

Article number: 204040M1280A1SK

Description: E+G levelling foot  
GN 40-40-M12-80-A1-SK

Note: SK With nut, External hexagon at the bottom

## Measures

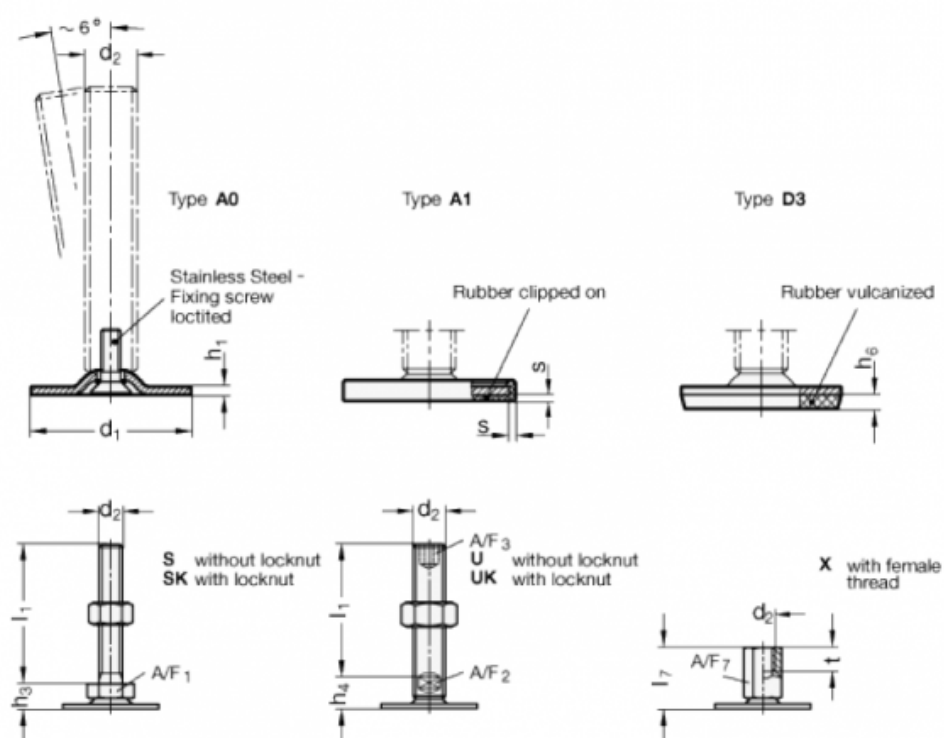

A/F1	=	17
d1	=	40
d2	=	M12
h1	=	2
h3	=	11
h6	=	
l1	=	80
s	=	1.5